

Quality - Ethical - Community



TICKET
TOTHE
MOON



2024 WORKBOOK



Help us
save TREES,
GO DIGITAL!

CONTENT LIST

Travel Line	08
Technical Line	20
Home Line	30
Accessories	38
Attachment Kits	54
Upcycled Collection	66
Lifestyle Products	92
Community	100

WHY WE DO WHAT WE DO!



At TTTM we have declared it our personal challenge to support all dreamers, and those who aspire to become dreamers, in the best possible way — enabling them to discover their fullest potentials by establishing an inspiring and transformative mindset. We strive to make the lives of our dear co-inhabitants on this wonderful planet as easy, adventurous, fun and as comfortable as possible by offering timeless and sustainable solutions with passion for fine details.

HOW WE DO IT!

We are certain that we all can only bring forward our personal best if our actions and interactions are co-operative, honest, fair, fun and sustainable. And so we act. In order to personalize your very own TTTM experience, we design and construct our gear in-house. This way, we can offer you the best products and include the exact features you desire at fair prices. As we sincerely believe that the best results can only be achieved by the deep collaboration, we welcome and live diversity in our international and multicultural team. This fact, combined with constant product analysis and development in our ongoing utopian search for perfection, keeps us at the forefront of innovation in hammock manufacturing. The entire range of Moon Hammocks is handmade by experienced craftspeople, some of whom have been with us since the beginning.

Using only the highest quality and skin-friendly (PFC-Free & OEKO-TEX® Standard 100) materials, each product is tested under extreme conditions and passes strict quality control procedures before it travels to you. The 10-year manufacturer's warranty covers any defects in workmanship and materials on all Ticket to the Moon products. GIVING BACK is vitally important to us! Hence, a significant amount of the profits directly go into TTTM's social projects, whose mission is to strengthen the resilience of disadvantaged communities in Indonesia. → [Page 102](#)

FAIR PRODUCTION!



Our long-term goal is to raise awareness of larger global challenges such as sustainability and fair production issues. In all our operations we aim to bring advancement to the community while respecting and supporting the local social structures. ACT LOCAL! The main part of our helpers and materials originate from Indonesia — our beloved nest and home. All our employees are over 18 years of age. Our honest, humane and fair corporate values mean that all staff within the TTTM family enjoy proper working conditions with social security, a pension, and a salary that

is far higher than the regional average. A big part of our profit is annually redistributed equally between employees, based on the number of years they have been with us. Everybody bonds into a unique social tribe, being passionate about our journey to the moon together.

MINIMIZING OUR CARBON FOOTPRINT



By using locally sourced materials and investing in innovative upcycling methods, we aim to have a minimal impact on the environment. This includes product and packaging design issues, and aspects of local manufacturing. Any spare fabric is turned into eco-friendly products or is recycled into new fabrics. The ongoing urge to minimize our carbon footprint engendered the motto: “nothing is left to waste because we care.”

“We live and work in Bali,
produced at our home”

PARACHUTE HAMMOCKS



Since 1996, Ticket to the Moon has been the original parachute nylon hammock manufacturer. Designed and created by travellers for travellers, our hammocks are tested in every climate around the world and are equally suitable for a serious adventurer's trip as well as daily use. Once you try a moon hammock, you'll never miss your tent again! Enjoy a comfortable sleep and «off the ground» protection from water, insects and small animals. Ticket to the Moon parachute hammocks have many handy attributes: lightweight yet robust, spacious but portable,

set up and takedown less than a minute, rot-resistant, machine washable and fast drying. The elastic and breathable nylon adjusts perfectly to your body contours, allowing for optimal blood circulation and relief. Hanging a hammock is often allowed, whereas pitching a tent is not. Our hammocks are delivered with stainless steel S-hooks or high-grade aluminium carabiners. Our hammocks are ideal for every occasion — whether you are travelling, spending a day in the park with friends, or just staying at home. Play, relax, take a nap or sleep all night in your Moon Hammock!



EXPRESS SETTING BAG

This unique and versatile feature comes together with all our hammocks and adds tremendously to their functionality. It enables you to set up and take down the hammock quickly.

HAMMOCKS: TRAVEL LINE

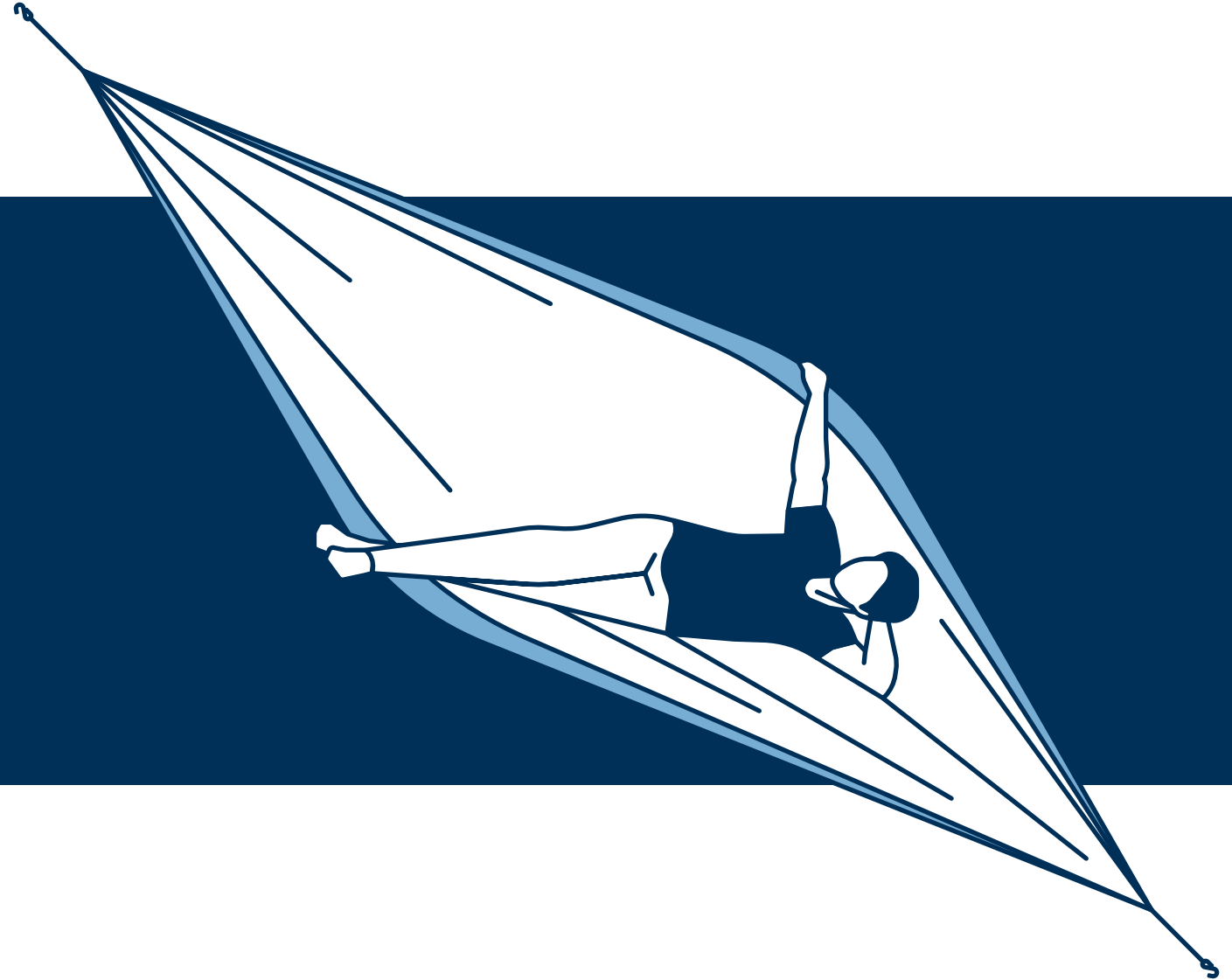

COMPACT



If minimalism and great value is your motto, then the Compact hammock is made for you. This stitchless hammock is durable, comfortable, easy to use and beautiful! It is also the perfect entry-level hammock for young users.



Express bag



S-hook



- Weight ————— 500 g
- Length hook to hook ————— 320 cm
- Width ————— 155 cm
- Max. load ————— 200 kg
- Fabric length ————— 300 cm
- Breaking strength ————— Hook >380 kg
- Carabiner >580 kg

(TMC)

2024 COLORS

- Royal Blue (TMC39)
- Turquoise (TMC14)
- Dark Green (TMC05)
- Army Green (TMC24)
- 2024 NEW COLOR! Emerald Green (TMC36)
- Brown (TMC08)
- Dark Yellow (TMC37)
- Orange (TMC35)
- Burgundy (TMC34)
- Purple (TMC30)

ORIGINAL



**TOP
SELLER!**

Our most famous and best-selling hammock. Wide and colourful, it delivers an amazing all night sleep at music festivals, late-night bonfires, in backyards, gardens and deep jungles. Featuring triple stitching, this is a genuinely durable and reliable companion.



Express bag



S-hook



- Weight ————— 600 g
- Length hook to hook ————— 320 cm
- Width ————— 200 cm
- Max. load ————— 200 kg
- Fabric length ————— 300 cm
- Breaking strength ————— Hook >380 kg
- Carabiner >580 kg

(TMO)

2024 COLORS

2024 NEW COLOR!
Emerald Green
& Green
(TMO3611)

Chocolate
& Brown
(TMO0408)

Army Green
& Brown
(TMO2408)

Burgundy
& Dark Yellow
(TMO3437)

Dark Green &
Army Green
(TMO0524)

Navy Blue
& Purple
(TMO0630)

Orange
& Dark Grey
(TMO3503)

Royal Blue
& Turquoise
(TMO3914)

Royal Blue
& Orange
(TMO3935)

Aqua
& Dark Grey
(TMO1503)

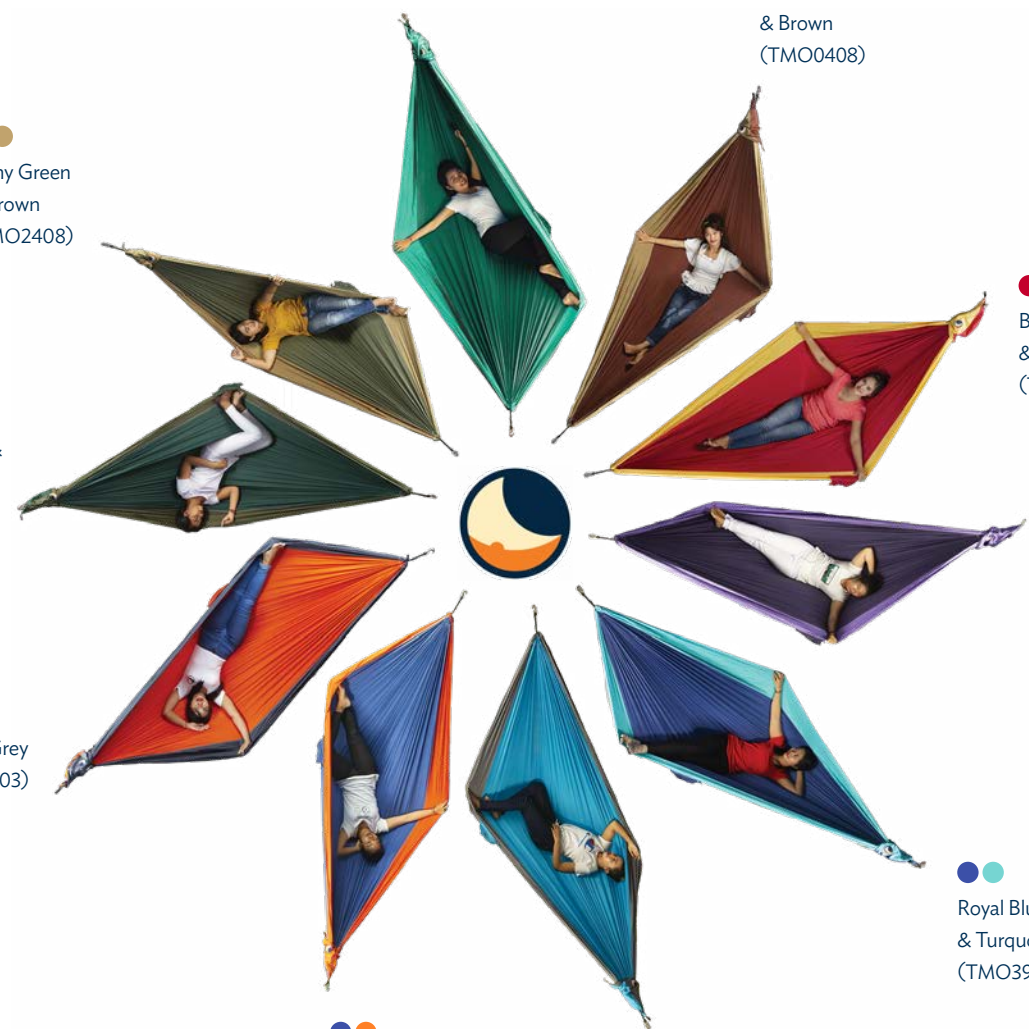

KING SIZE



TTTM TEAM FAVORITE!

An even wider version of the Original Hammock, ideal for taller users or for anyone looking for extra comfort in life. There is enough room for a friend to share that unforgettable sunset with.



Express bag



S-hook

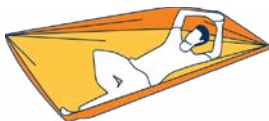

- Weight ————— 700 g
- Length hook to hook ————— 320 cm
- Width ————— 230 cm
- Max. load ————— 200 kg
- Fabric length ————— 300 cm
- Breaking strength ————— Hook >380 kg
- Carabiner >580 kg

(TMK)

2024 COLORS

- 2024 NEW COLOR!**
Emerald Green & Green (TMK3611)
- 2024 NEW COLOR!**
Navy Blue & Navy Blue (TMK0606)
- 2024 NEW COLOR!**
Burgundy & Dark Yellow (TMK3437)
- 2024 NEW COLOR!**
Brown & Brown (TMK0808)
- 2024 NEW COLOR!**
Royal Blue & Turquoise (TMK3914)
- 2024 NEW COLOR!**
Aqua & Dark Grey (TMK1503)
- Royal Blue & Orange (TMK3935)
- Orange & Dark Grey (TMK3503)
- Dark Green & Army Green (TMK0524)
- Army Green & Brown (TMK2408)

MINI SET



- Weight ————— 200 g
- Length hook to hook — 160 cm
- Width ————— 100 cm
- Max. load ————— 200 kg
- Fabric length ————— 130 cm
- Breaking strength ——— >350 kg

(TMMI)



This astonishingly versatile bundle of joy is primarily a great hammock for the first years of life. A gentle swing here and there is all it takes to bring extra peace into parenting. Additionally, it can work brilliantly to keep your gear off the ground.



Express bag



6 kN



Rope set (2x)

2024 NEW COLORS!



Dark Grey (TMMI03)



Dark Green (TMMI05)



Emerald Green & Green (TMMI3935)

HONEYMOON SET

(TMHM)



The Honeymoon Hammock is the ultimate option for those who aim for maximum comfort. It is much more spacious than a King Size, yet easier to install than our Mammock. You might even consider adding a mattress inside and get surprised by this sensation. It is ideal for couples, and larger folks.

Colors



Army Green & Brown (TMHM2408)



Royal Blue & Turquoise (TMHM3914)



Burgundy & Dark Yellow (TMHM3437)



Orange & Dark Grey (TMHM3503)



- Weight ————— 1420 g
- Length hook to hook — 500 cm
- Width ————— 300 cm
- Max. load ————— 300 kg
- Fabric length ————— 480 cm
- Breaking strength ——— >760 kg



Express bag



Hammock sleeve

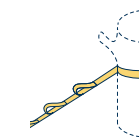

Moon Straps (2x)



22 kN carabiners

MAMMOCK SET

18

(TMM)



19

The Mammoth is our biggest hammock — it was designed with parties and fun in mind. The center of attention in any garden, event or school, the Mammoth easily accommodates you and your friends with plenty of room for a chat, a laugh or even a dance!



- Weight — 3420 g
- Length hook to hook — 800 cm
- Width — 450 cm
- Max. load — 350 kg
- Fabric length — 780 cm
- Breaking strength — >760 kg

2024 NEW COLOR!



**Emerald Green
& Green
(TMM3611)**



Express bag



Hammock sleeves

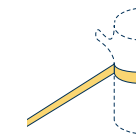

Garden Strap & Rope (2x)



22 kN carabiners

**HAMMOCKS:
TECHNICAL LINE**

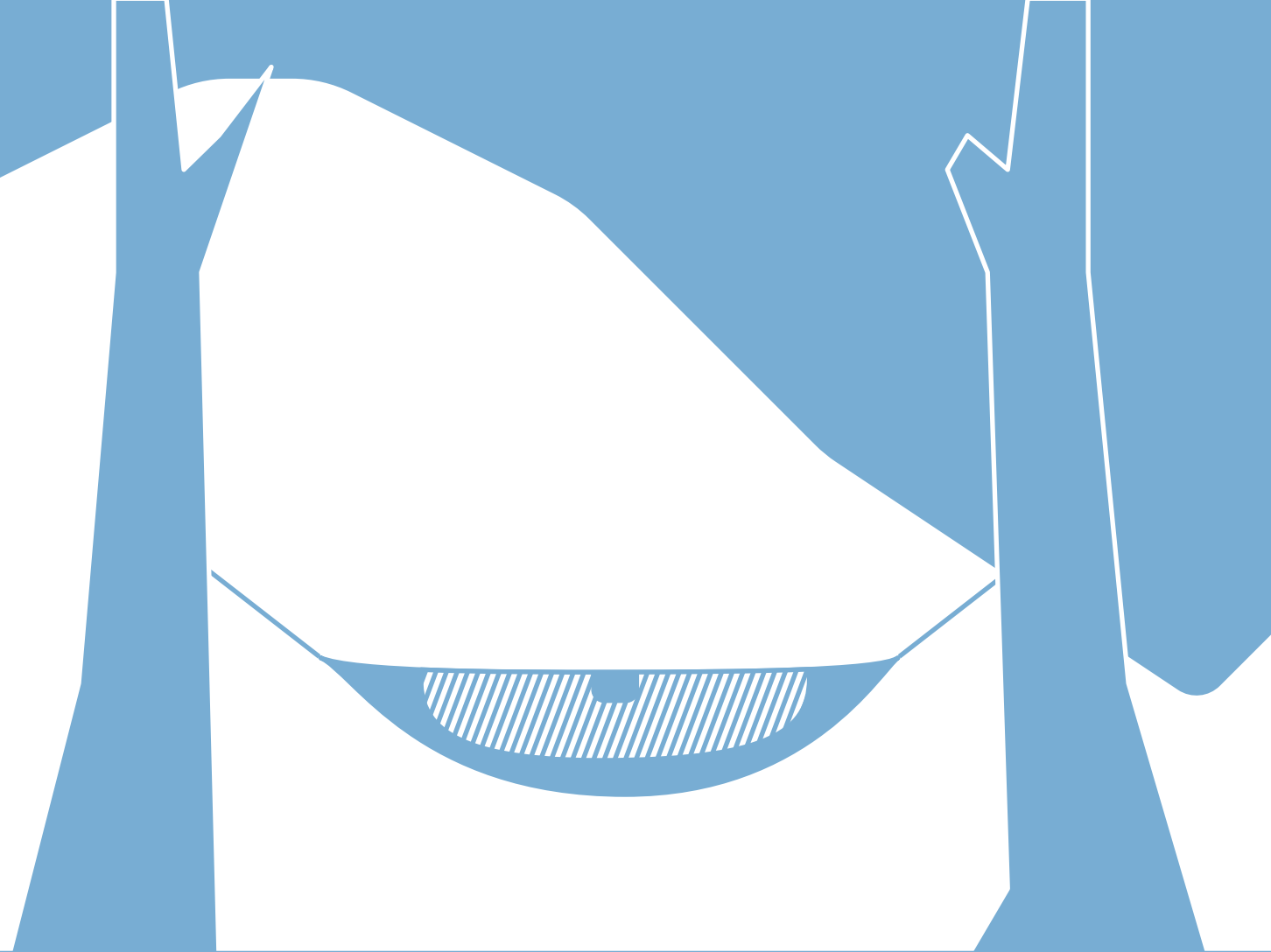

NEW!



When going far, or if for you every gram counts, even a conventional travel hammock may be too heavy. Others just love the idea of having a hammock that can be truly brought anywhere, and always without having to leave other things behind. After many years of searching for an even lighter fabric that provides the level of safety and comfort typical for Ticket To The Moon, we are excited to present our Lightest Hammock.

It is an ultralight setup that is made of a locally produced, recycled high-performance crinkle nylon textile. This award-winning packing wonder with a full length of 300 cm hammock body is suitable even for taller people without compromises in comfort. It weighs only 228 grams including the express setting bag, and with 6 kN mini-carabiners and special UHMWPE-rope it will literally fit into your pocket.



Material	41 g/m ² Recycled-Crinkle Nylon
Weight	228 g
Max. load	150 kg
Length	320 cm (carabiner to carabiner)
Fabric length	300 cm
Width	140 cm
Breaking strength	>450 kg



Express bag



6 kN carabiners

- Lightweight Design
- Full length
- High Grade Nylon
- Packed in Express Setting Bag
- Spliced UHMWPE ropes



Forest Green (TMLR51)



Navy Blue (TMLR52)



Orange (TMLR53)

LIGHTEST PRO

NEW!

The TTTM PRO Hammocks are the serious adventurer's choice and therefore are designed as an easy-to-use and always-ready solution for sleeping outdoors with insect protection and ridgeline. Extra effort has been given to maximise comfort and functionality while minimising weight. Set up in less than a minute, its extended 310 cm hammock body gives you extra room to spread out and enjoy astonishing comfort, particularly when lying at an angle.

“No-see-um” insect protection — the integrated yet stowable bug net made from carefully selected premium micromesh fabric provides excellent insect protection, lets you breathe easily and it will also deflect wind to provide a calm space inside. Four zipper heads with handles allow convenient double-sided access.

Material	41 g/m ² Recycled-Crinkle Nylon
Weight	590 g
Max. load	100 kg
Length	325 cm (carabiner to carabiner)
Fabric length	310 cm
Width	140 cm
Breaking strength	>450 kg



Express bag



6 kN carabiners

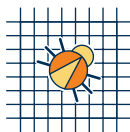

Mosquito net



Ridgeline & organiser

- Stowable 200 holes/cm² micromesh convertible bug net incl. 4 zipper heads for two-side easy access
- Integrated structural ridgeline 3 mm UHMPE 2.8 m +-10 cm
- Ridgeline organiser / storage bag for bug net and other gear
- Packed in Express Setting Bag
- External loops to guide your Underquilt, attach gear or use as tie-outs

(TMLPROR)



Forest Green
(TMLPROR51)



Navy Blue
(TMLPROR52)



Orange
(TMLPROR53)

ORIGINAL PRO

(TMOPRO)

UPDATED DESIGN & WIDTH!

Perfect hang guaranteed every time — an integrated and adjustable ridgeline maintains the same comfortable shape every time to keep your back straight and level when resting diagonally. It comes with a handy organiser/storage bag system for the net and for personal gear. External loops let you neatly guide your underquilt, attach your gear and serve as tie-outs to make sure you are smitten, not bitten, on your trip. The ORIGINAL PRO offers the same features as its lightweight sibling, while we added extra width for even more comfort during your journeys. Made of our popular 64 g/m² standard travel range nylon, it is more robust and less stretchy, which opens this versatile adventure tool even for couples, and larger folks.

Material	Parachute Nylon
	64 g/m ²
Weight	950 g
Max. load	150 kg
Length	325 cm
	(carabiner to carabiner)
Fabric length	310 cm
Width	170 cm
Breaking strength	>450 kg



Express bag



6 kN
carabiners

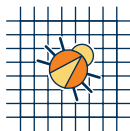

Mosquito net

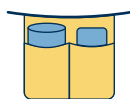

Ridgeline
& organiser

- Stowable 200 holes/cm² micromesh convertible bug net inc. 4 zipper heads for two-side easy access
- Integrated structural ridgeline 3 mm UHMPE 2.8 m +-10 cm
- Ridgeline organiser / storage bag for bug net and other gear
- Packed in Express Setting Bag
- External loops to guide your Underquilt, attach gear or use as tie-outs



Army Green
(TMOPRO2424)



2024 NEW COLOR!
Brown
(TMOPRO807)



Burgundy
(TMOPRO3407)

MAT HAMMOCK



While we are convinced that our Moonquilt series offers the best sleeping comfort in the outdoors, we see that there are a few scenarios in which a mattress-friendly hammock solution can save the day. This 1.7 m wide hammock comes with a pocket that fits all standard mattresses. To make sure that you are as comfortable as possible, we included a ridgeline into this hammock- perfect sag guaranteed! With this new travel companion, even when hanging your hammock is not possible you can still rest on the ground instead.

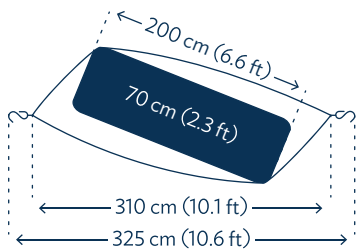

- Weight ————— 620 g
- Carabiner to carabiner ————— 325 cm
- Fabric length ————— 310 cm
- Width ————— 170 cm
- Breaking strength ————— >450 kg

Colors

- Navy Blue (TMMAT06)
- Army Green (TMMAT24)

- Express bag
- 6 kN carabiners
- Ridgeline & organiser

PRO MAT HAMMOCK



The Pro Mat hammock additionally offers mosquito and bug protection. It is an intuitive allround outdoor hammock.

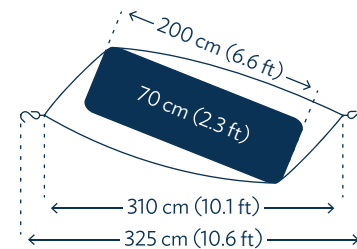

- Weight ————— 620 g
- Carabiner to carabiner ————— 325 cm
- Fabric length ————— 310 cm
- Width ————— 170 cm
- Breaking strength ————— >450 kg

Colors

- Navy Blue (TMPROMAT06)
- Army Green (TMPROMAT24)

- Express bag
- 6 kN carabiners
- Mosquito net
- Ridgeline & organiser

HOME & GARDEN LINE

NEW

Introducing the new "Home Hammock" line, a perfect addition to your home decor. This line of hammocks has arrived with upgraded features that will make your lounging experience better than ever before. The material used in the production of these hammocks is stronger, making them capable of supporting heavy weight without compromising on comfort. The "Home Hammock" line comes in six natural color tones, ensuring that you'll find a perfect match for your home. The variety in colors also makes them a perfect fit for outdoor spaces, allowing you to enjoy the sunshine while lounging in style in your garden.

In addition to the upgraded material and color options, each hammock in the "Home Hammock" line is equipped with rope, carabiner, and sleeves for easy setup and use. This means that you won't have to worry about purchasing any additional equipment to enjoy your new hammock. Simply unpack it, set it up, and relax in comfort.



Home

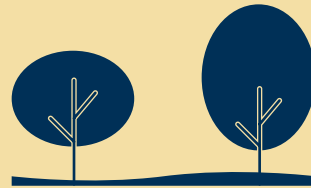

Garden



HOME HAMMOCKS



What are we so excited about? They come in three sizes and shine in six sparkling earth tones. This special blend of selected threads and refined weaving technique boasts with a particularly soft touch on the skin, yet the fabric will allow you to sink in exactly where you want to. The thicker material is more robust and less sensitive to UV light, which considerably extends

the lifetime of your home hammock. The stretch is right on the point and with the included sleeve you can leave it outside all the time or enjoy the elegant and sleek style. They can all be used by two or more people, while you can also dive in all by yourself. An excellent piece of furniture and a travel option for all vanlifers and less weight-sensitive explorers!



Carabiners

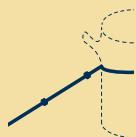

Elegant pouch

Nautical ropes
(2x)Hammock
sleeve

HOME HAMMOCK 320

(TMHOME320)



If you are looking for a true allround hammock that is suitable for both couples and solo usage and that combines the advantages of a parachute silk hammock with a cottony touch, you will love our 320 hammocks. With its compact pouch, it is also a viable option for you to take along on your journeys when lightweight is not of the essence.

Weight	1.22 kg
Carabiner to carabiner	320 cm
Width	230 cm
Max. load	300 kg
Fabric length	300 cm
Breaking strength	>580 kg

Colors

Frosty Grey
(TMHOME
320-49)Natural Beige
(TMHOME
320-41)Sage Green
(TMHOME
320-47)Terracotta
Orange
(TMHOME
320-45)Olive Brown
(TMHOME
320-43)Sparkling Gold
(TMHOME
320-23)

HOME HAMMOCK 420



This spacious allrounder is perfect for chilling after work. It combines lavish comfort with a more versatile length that fits easier into your living room, your porch or between your favourite trees in the garden.

Weight	1.88 kg
Carabiner to carabiner	420 cm
Width	300 cm
Max. load	300 kg
Fabric length	400 cm
Breaking strength	>980 kg

Colors



Frosty Grey
(TMHOME
420-49)



Natural Beige
(TMHOME
420-41)



Sage Green
(TMHOME
420-47)



Terracotta
Orange
(TMHOME
420-45)



Olive Brown
(TMHOME
420-43)



Sparkling Gold
(TMHOME
420-23)

HOME HAMMOCK 520



This is probably the most comfortable hammock in our entire range — for solo dreamers as well as for families. It might just transform the naked corner in your living room into your new favourite spot around your house, or spending time out in the garden more luring.

Weight	2.26 kg
Carabiner to carabiner	520 cm
Width	300 cm
Max. load	300 kg
Fabric length	500 cm
Breaking strength	>980 kg

Colors



Frosty Grey
(TMHOME
520-49)



Natural Beige
(TMHOME
520-41)



Sage Green
(TMHOME
520-47)



Terracotta
Orange
(TMHOME
520-45)



Olive Brown
(TMHOME
520-43)







Sparkling Gold
(TMHOME
520-23)

HOME HANGING CHAIR

A silk nylon seat and polished teak bars, this hanging chair bears Ticket to the Moon signature: a neat hand-finish for optimal comfort in the garden and the indoors. Comfortably installed in your chair, the footrest guarantees a state of well-being and total relaxation.

- Weight ————— 2 kg
- Wooden bars ————— 3 x 4 cm +
Ø 2.4 cm
- Max. load ————— 120 kg

Colors

-  Frosty Grey (TMHOME CHAIR-49)
-  Natural Beige (TMHOME CHAIR-41)
-  Sage Green (TMHOME CHAIR-47)
-  Terracotta Orange (TMHOME CHAIR-45)
-  Olive Brown (TMHOME CHAIR-43)
-  Sparkling Gold (TMHOME CHAIR-23)



- High-grade parachute nylon
- Skin friendly
- Fast-drying and mildew resistant
- Adjustable (length-adjustable footrest)
- Incl. suspension

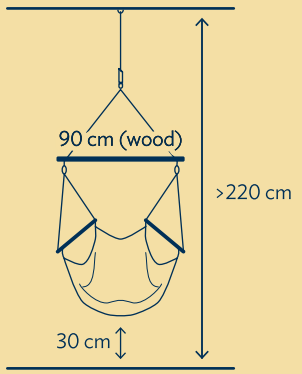

HAMMOCK ACCESSORIES



MOON TARP



Material	PU — coated ripstop nylon
Weight	700 g
Size	250 × 250 cm
Diagonal	350 cm
Guy rope: Blue	2 × 2.5 m
Yellow	4 × 2 m
<i>(Incl. carabiners & quick-release-tension-buckles)</i>	

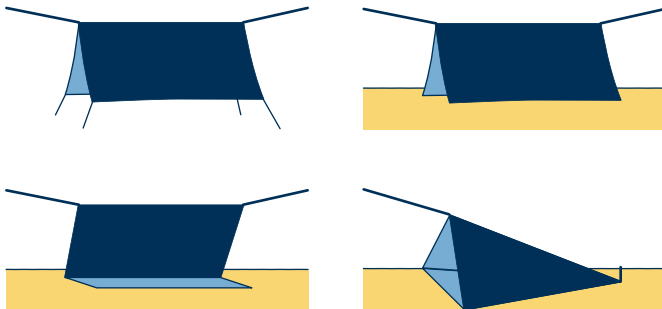

TOP SELLER!

This diamond-shaped tarp can be used with standard hammocks, or on its own as an instant protection from the elements. The reinforced seam-sealed corners and tie-out points make it very durable and adaptable. The blue coloured ridgeline tie-outs come with carabiners for easy orientation and fast installation. Four additional eyelets allow for different set-up modes using additional cordage or poles. The adjustable guy lines are kept in convenient breathable corner pockets for safekeeping.

- Waterproof 2000 mm
- Covers all TTTM hammocks except Honeymoon and Mammoth
- Shields from rain/sun/wind
- Includes 2 × Y-shaped 18 cm aluminium pegs and 4 adjustable guy lines
- Quick-release buckles for easy set-up
- Compact and lightweight
- Comes in Moon Pouch
- Contrast color ridge line for easy set up with carabiners
- Mesh pockets for all guy lines

FULLMOON TARP ♻️



Material	20D recycled ripstop sil-nylon (1500 mm water column)
Min. weight	585 g
Max. weight	750 g
Size	320 × 280 cm
Diagonal	424 cm
Guy rope: Blue	2 × 2.5 m
Yellow	8 × 1.5 m + 2 × 0.35 m
Orange	4 × 1 m
<i>(Incl. carabiners & quick-release-tension-buckles)</i>	

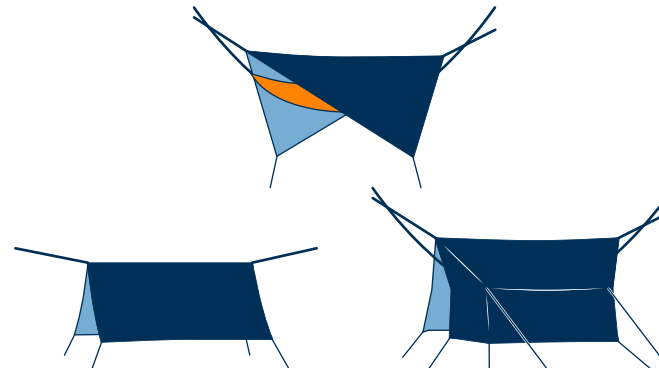

(TMFMTARP)

TTTM TEAM FAVORITE!

The Fullmoon Tarp is an advanced all-weather protection that you can set up in a variety of configurations. Whether it be an A-frame tent-like shelter in challenging weather, or as a diamond tarp with maximum airflow and visibility in milder conditions — we have you covered. Thanks to the durable and high-grade 20D Sil-Nylon fabric, this tarp is not only fully waterproof and lightweight, it is also pretty quiet even in heavy rain.

- Waterproof 1500 mm
- Covers all TTTM hammocks except Honeymoon and Mammoth
- Shields from rain/sun/wind
- Includes 6 × Y-shaped 18 cm aluminium pegs and 12 adjustable guy lines
- Quick-release buckles for easy set-up
- Compact and lightweight
- Comes in Moon Pouch
- Seam sealer and repair patch included
- Contrast color ridge line for easy set up with carabiners
- Mesh pockets for all guy lines

LIGHTEST TARP



Material	20D recycled ripstop sil-nylon (1500 mm water column)
Min. weight	373 g
Max. weight	412 gr
Size	250 × 250 cm
Diagonal	350 cm
Guy rope: Blue	2 × 2.5 m
Yellow	4 × 2 m
<i>(Incl. carabiners & quick-release-tension-buckles)</i>	

(TMLTARP)

MINIMALIST'S CHOICE!

- Waterproof 1500 mm
- Covers all TTTM hammocks except Marmot and Honeymoon
- Shields from rain/sun/wind
- Includes 2 × Y-shaped 18 cm aluminium pegs and 4 adjustable guy lines
- Quick-release buckles for easy set-up
- Compact and lightweight
- Comes in Moon Pouch
- Seam sealer and repair patch
- Contrast color ridge line for easy set up with carabiners
- Mesh pockets for all guy lines

Fast protection from rain, sun and wind, while cutting weight to a minimum! Install it high for maximal shadow and air-flow, or low to keep rain and wind away. The reinforced sides, corners and tie-out points make this minimalist piece of gear impressively sturdy. The Sil-Nylon 20D material enables the Lightest Tarp to offer full features, as it comes with quick-release tension buckles on all four corners, two pegs and extra tie-out loops. The blue coloured ridgeline tie-outs come with carabiners for easy orientation and fast installation. You will surely love it. All guy lines are kept conveniently in breathable pockets so they do not get tangled.

CONVERTIBLE BUG NET 360°

(TMNET)



Netting	200 mesh openings/cm ²
Weight	485 g
Size	300 × 130 cm

You want to enjoy full protection, great functionality, a minimum of weight and yet be able to breathe easily? With this versatile 485 g net you will no longer be bitten from below thanks to the smart 360° set-up! It is compatible with standard hammocks (without spreader bars). The soft yet robust polyester mesh will even keep away the tiniest insects, snakes, rodents and other critters. The fully convertible top quickly opens thanks to double circular YKK zippers — for extra freedom of movement when the coast is clear or you want to increase airflow. Put a shirt into the soft pouch and use it as a pillow. For starlovers, we recommend the black net.

★★ Starlover's choice



White
(TMNET01)



Green
(TMNET24)



Black
(TMNET07)

- Double zipper opens entire top
- Includes adjustable ridgeline
- 360° protection
- Extra fine mesh (200 holes/cm²)
- 100% polyester
- Washable at 30°C
- Mildew resistant
- Compact and lightweight

MOONQUILT ALLROUND



Outer material	20D Crinkle Nylon
Inner material	70D Crinkle Nylon (upcycling material from hammock fabrics)
Weight	1280 g (1120 g quilt + 100 g hood) + 60 g storage bag
Size	200 × 140 cm
Filling	115 g/m ² 100% RPET Insulation ECODOWN by Thermore®
Moonquilt Temp. Range	>5°C (comfort)
Sleeping bag Temp. Range	8°C (comfort) 5°C (limit) 0°C (extreme)

The Allround is the successor of our original Moonquilt and its name already gives it away. Besides being one of the best Underquilts on the market, it offers a lot of functionality. In windy conditions, you can zip up the recycled synthetic three-season underquilt. It so completely envelops you and your hammock. The two zippers and adjustable elastic shock cords let you conveniently adjust the level of insulation from within your hammock. Small pockets on the corners keep cords and mini carabiners neatly packed away when using it as a sleeping bag or blanket. In style, we also include a hidden pouch to keep essentials at hand.

- Detachable Hood
- Machine Washable at 30°C
- Mildew Resistant
- Water repellent
- Underquilt use
- Blanket use
- Sleeping bag use (even around the hammock)
- All-In-One solution

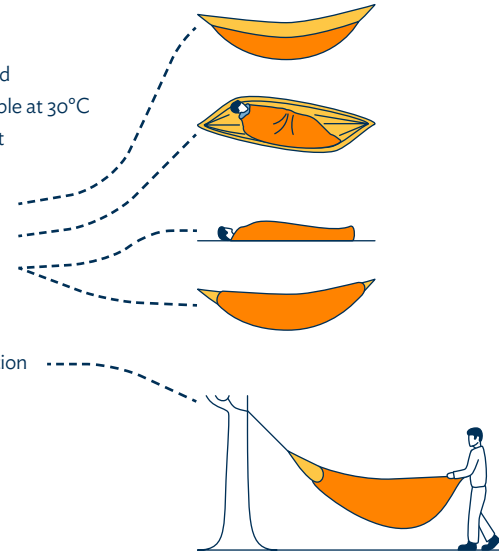

(TMMQA)

MOONQUILT COMPACT



The Moonquilt Compact is a minimalistic, yet comfortable and ready-to-use three-season underquilt. Fabricated mainly from recycled materials, it works brilliantly with standard hammocks and our Moonblankets.

(TMMQC)

Outer material	20D Crinkle Nylon
Inner material	70D Crinkle Nylon (upcycling material from hammock fabrics)
Weight	845 g (790 g quilt + 55 g bag) + 60 g storage bag
Size	210 × 135 cm
Filling	115 g/m ² 100% RPET Insulation ECODOWN by Thermore®
Moonquilt Temp. Range	>5°C (comfort)



MOONQUILT PRO 650 (TMMQP650)



As the first company in Bali with a down-importing licence, we decided to get right to it and are proud to present this unique duo of down underquilts. They come in 650 and 850 Fillpower (Nikwax hydrophobic DWR and RDS certified) duck down and will surely keep you as warm and comfy during your adventures as only down can. The 650 model is rated until 2°C comfort (even for sensitive people), while with the Pro 850, you can hammock below freezing. To keep them lightweight, we decided to use our super soft 20D lightest fabric.

MOONQUILT PRO 850 (TMMQP850)



- Conscious high-performance duck down
- Compatible with standard hammocks
- Lightweight
- Resists wetting
- Maintaining the insulation properties and breathability even when moist
- Exceed 10.000 minutes on the industry IDFB 18 a Shake Test. That's 7 days constant exposure to water.

Illustration of the size comparison between a coin & duck down fill power:

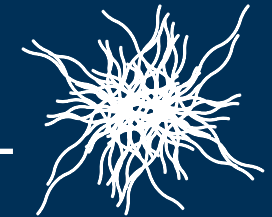

MOONQUILT PRO 650

Outer material	20D Crinkle Nylon Downproof
Inner material	20D Crinkle Nylon Downproof
Weight	740 g (695 g quilt + 45 g bag) + 60 g storage bag
Size	210 × 135 cm (115 cm in the middle)
Filling	NHD® certified in RDS® (650 fill power; 280 g down)
Moonquilt Temp. Range	>2°C (comfort)

650 & 850 FP comparison:



MOONQUILT PRO 850

Outer material	20D Crinkle Nylon Downproof
Inner material	20D Crinkle Nylon Downproof
Weight	795 g (750 g quilt + 45 g bag) + 60 g storage bag
Size	210 × 135 cm (115 cm in the middle)
Filling	NHD® certified in RDS® (850 fill power; 325 g down)
Moonquilt Temp. Range	>-2°C (comfort)

MOONBLANKET



- Minimalistic and convertible:
Topquilt, Blanket and Poncho
- Sustainable materials used
- Mildew resistant
- Water-repellent
- Keeps you warm, even when moist
- Footbox
- Neck protection

We are happy to announce our new range of Topquilts for next-level adventures with or without your hammock. Our colleagues in Bali affectionately refer to them as “Sombreros”. For clarity reasons, we still decided to name them Moonblankets. They are the counter-part or rather the addition to our Moonquilt range. At the same time, they are much more and it will often make sense to bring them along even if hammocking is not on the agenda.

MOONBLANKET COMPACT



We are happy to announce our new range of Topquilts for next-level adventures with or without your hammock. Our colleagues in Bali affectionately refer to them as “Sombreros”. For clarity reasons, we still decided to name them Moonblankets. They are the counter-part or rather the addition to our Moonquilt range. At the same time, they are much more and it will often make sense to bring them along even if hammocking is not on the agenda.

Outer material — 20D Crinkle Nylon
 Inner material — 70D Crinkle Nylon
 (upcycling material from hammock fabrics)
 Weight — 800 g (855 g blanket & bag)
 Size — 205 × 135 cm
 Filling — 100% RPET Insulation
 ECODOWN by Thermore®
 Moonblanket Temp. Range — >5°C
 (comfort)

(TMBCOM52)

MOONBLANKET PRO 650 (TMBPRO650)

MOONBLANKET PRO 650

Outer material — 20D Crinkle Nylon
 Downproof
 Inner material — 20D Crinkle Nylon
 Downproof
 Weight — 740 g
 (655 g blanket & 45 g bag)
 + 60 g storage bag
 Size — 205 × 135 cm
 Filling — NHD® certified in RDS®
 (650 fill power;
 280 g down)
 Moonblanket Temp. Range — >2°C
 (comfort)

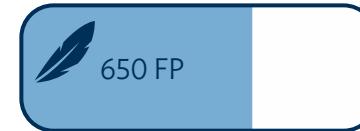

MOONBLANKET PRO 850 (TMBPRO850)

MOONBLANKET PRO 850

Outer material — 20D Crinkle Nylon
 Downproof
 Inner material — 20D Crinkle Nylon
 Downproof
 Weight — 795 g
 (750 g blanket & 45 g bag)
 + 60 g storage bag
 Size — 205 × 135 cm
 Filling — NHD® certified in RDS®
 (850 fill power;
 325 g down)
 Moonblanket Temp. Range — >-2°C
 (comfort)

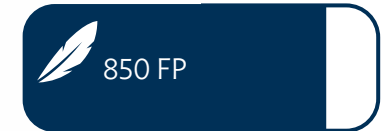

- Lightweight and convertible design
- Two versions: 650 and 850 Fillpower (Nikwax hydrophobic DWR and RDS certified) duck down
- Conscious high-performance materials
- Compatible with standard hammocks
- Resists wetting
- Maintaining the insulation properties and breathability even when moist
- Exceed 10,000 minutes on the industry IDFB 18 a Shake Test. That's 7 days constant exposure to water.

UV SLEEVE

(TMHSUV)

200%
UV STABILITY!



Protects your hammock like a second skin. An essential optional accessory if you plan to leave it in the sun for an extended time. It keeps your hammock clean and stops the wind from flapping it around when not in use.

RIDGELINE

(TMRIDGE)



- UHMPE adjustable ridgeline 220-320 cm
- 2× 6 kN carabiners
- Organizer (6 compartments)
- Stainless-steel rings
- Adjustment handles

With this structural and adjustable ridgeline kit, you will certainly hang like a pro and find your perfect position-everywhere and always! Installation is super easy, and you will sleep much better! A clever fusion of state-of-the-art materials and locked Brummel eye splice loop and whoopie sling technology make this new accessory attractive for everyday use. With two 6 kN carabiners (7075 aluminium) it can be attached to the hammock and by simply holding and pulling on the marked spots, it can be shortened and extended to a maximum length of 320 cm.

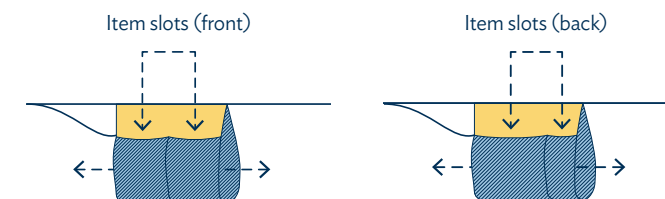

Material	PU coated 3 mm UHMWPE rope
Weight	80 g
Length	220 - 320 cm
Max. load	200 kg
Breaking strength	450 kg

ATTACHMENT KITS



NAUTICAL ROPE KIT



Extremely durable, sturdy and safe hanging system. This minimalistic approach, invented by Ticket to the Moon more than 25 years ago, changed the hammock world forever. Anyone can hang a hammock in seconds, without tying any knots.

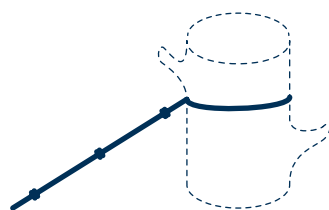

Length — 2.4 m
 Diameter — Ø 5 mm
 (preknotted)
 Weight — 230 g
 Max. load — 200 kg
 Material — 100% Nylon
 Breaking strength — >580 kg

MOON STRAPS

(TMSTRAP)



TTTM TEAM FAVORITE!

This daisy-chain webbing is super strong, anti-slip, and extremely easy to use. Perfect for application on trees with a sensitive bark, or for hammocks that are used by more than one individual.

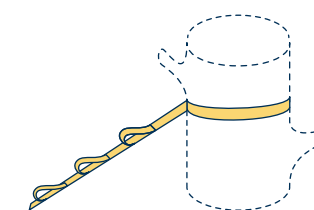

Length — 2.7 m
 Width — 2 cm
 Weight — 216 g
 Max. load — 300 kg
 Material — 100% Polyester
 Breaking strength — >760 kg

LIGHTEST STRAP



ULTRALIGHT!

For only 95 g you get a tree-friendly and easy to use solution. Perfect if weight matters. Made from UHMWPE rope to last. It even fits into the express bag of the lightest hammock and comes in a pair.

Two pieces per pouch!

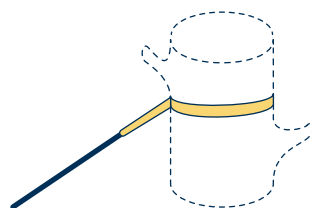

Full length ————— 2.5 m
 Tree-hugger — L: 0.9 m | W: 20 cm
 Rope — L: 1.6 m | Ø 3 mm
 Weight ————— 95 g
 Max. load ————— 200 kg
 Strap material — 100% Polyester (PES)
 Rope material — UHMWPE
 Breaking strength — >400 kg

STRAP EXTENDER

(TMSE)



Has it ever happened to you that there were lousy 10 cm missing between your hook and the ropes to hang your hammock? Sometimes trees are thicker and / or further apart than you are prepared for. This is where the Strap Extender comes in. With a pair of tree-friendly polyester straps it becomes easy to extend and / or upgrade your Lightest or Moon Strap or your Ropes.

Two pieces per pouch!

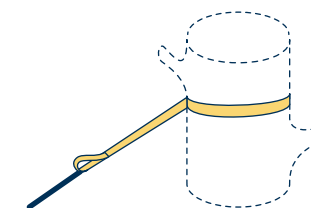

Length ————— 1.55 m
 Width ————— 2 cm
 Weight ————— 105 g
 Max. load ————— 300 kg
 Material ————— Polyester
 Breaking strength — >760 kg

GARDEN STRAP



2024 NEW!

You want to be absolutely sure that the trees are only hugged and not hurt when installing your hammock? Pair of strap extenders is optimized for permanent setups, for trees with sensitive bark and for all those that would like to give extra love to trees. They are compatible with all standard attachment systems.

Two pieces per pouch!

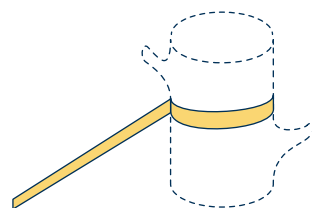

Full length — 1.5 m
 Weight — 240 g
 Max. load — 500 kg
 Strap material — 100% Polyester (PES)
 Breaking strength — >1200 kg

(TMGS)

ANCHOR KIT



When back home from your travels, why not set up your hammock in the living room? A perfect place to read a book, plan your next trip, or simply enjoy some well-deserved relaxation time. Suitable for application on concrete, bricks and wood.

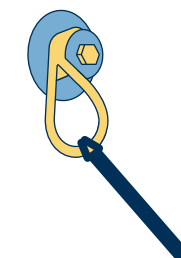

Max. load — 200 kg
 Material — Stainless Steel

Set of 2 hangers with screws, washers and fisher plugs.

(TMWALL)

CARABINER 10 KN



If you like to attach gear to your hammock, or feel the need for extra safety for your joyfully playing children, upgrade to our weight-rated carabiners. They were redesigned recently to even better secure your hammock, while saving weight. More so, you will love the additional comfort in setting up your hammock.

Two pieces per pack!



Size ————— 6 × 3.9 cm
 Material ————— A7075 T6
 Weight ————— 14.5 g/pc
 Closed  ————— 10 kN
 Opened  ————— 3.5 kN

CARABINER 22 KN



In case you feel that you want to have even more safety, you will like this carabiner. The extra strength allows you to effortlessly open the gate of the carabiner, while two dreamers are chilling in their hammock.

Two pieces per pack!



Size ————— 8.5 × 5.2 cm
 Material ————— A7075 T6
 Weight ————— 34.4 g/pc
 Closed  ————— 22 kN
 Opened  ————— 7 kN

CARABINER 6 KN



We designed this carabiner as the most lightweight option. Strong enough in any situation with its 600 kg closed gate rating, it has a custom eyelet for ropes like our UHMPE ropes. Suitable for our Lightest Hammock, it also works as a high-strength accessory carabiner.

Two pieces per pack!



Size ——— 4.5 × 2.6 cm
Material ——— A7075 T6
Weight ——— 6 g/pc
Closed  6 kN
Opened  1.5 kN

ACCESSORY CARABINER

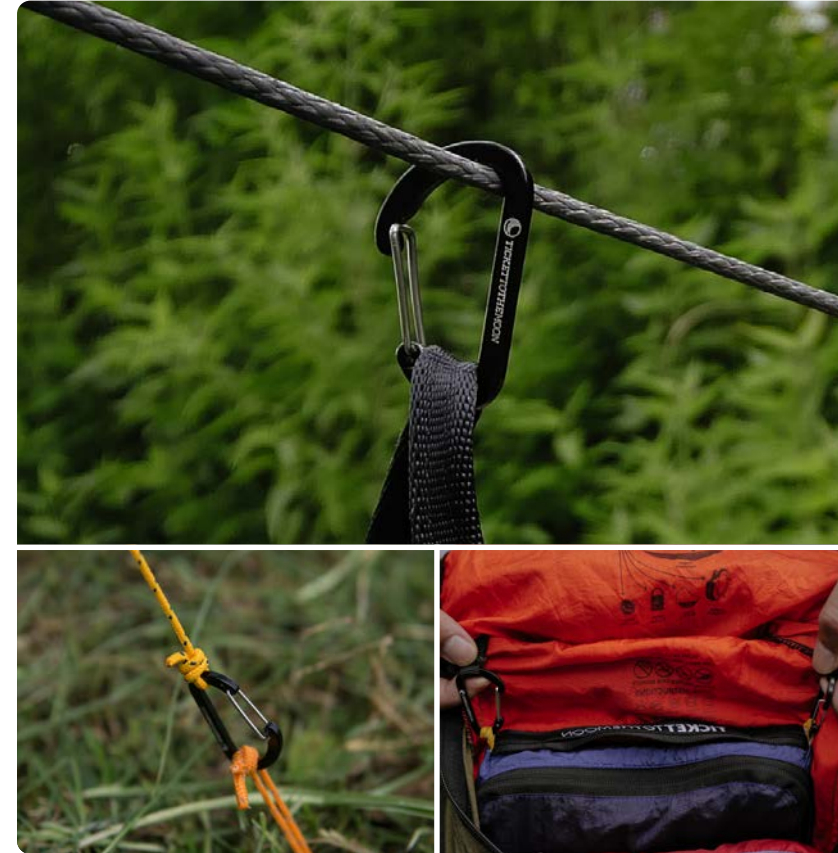

The perfect clips for securing smaller items like water bottles, knives, and flashlights to your Ticket to the Moon bag. These carabiners function well as key rings and more, while accommodating guy lines.

One set contains 8 pieces.



Size ——— 4 × 2.5 cm
Material ——— A6061
Weight ——— 3 g/pc
Closed  30 kg

UPCYCLED COLLECTION



Nothing is left to waste!

WE UPCYCLE

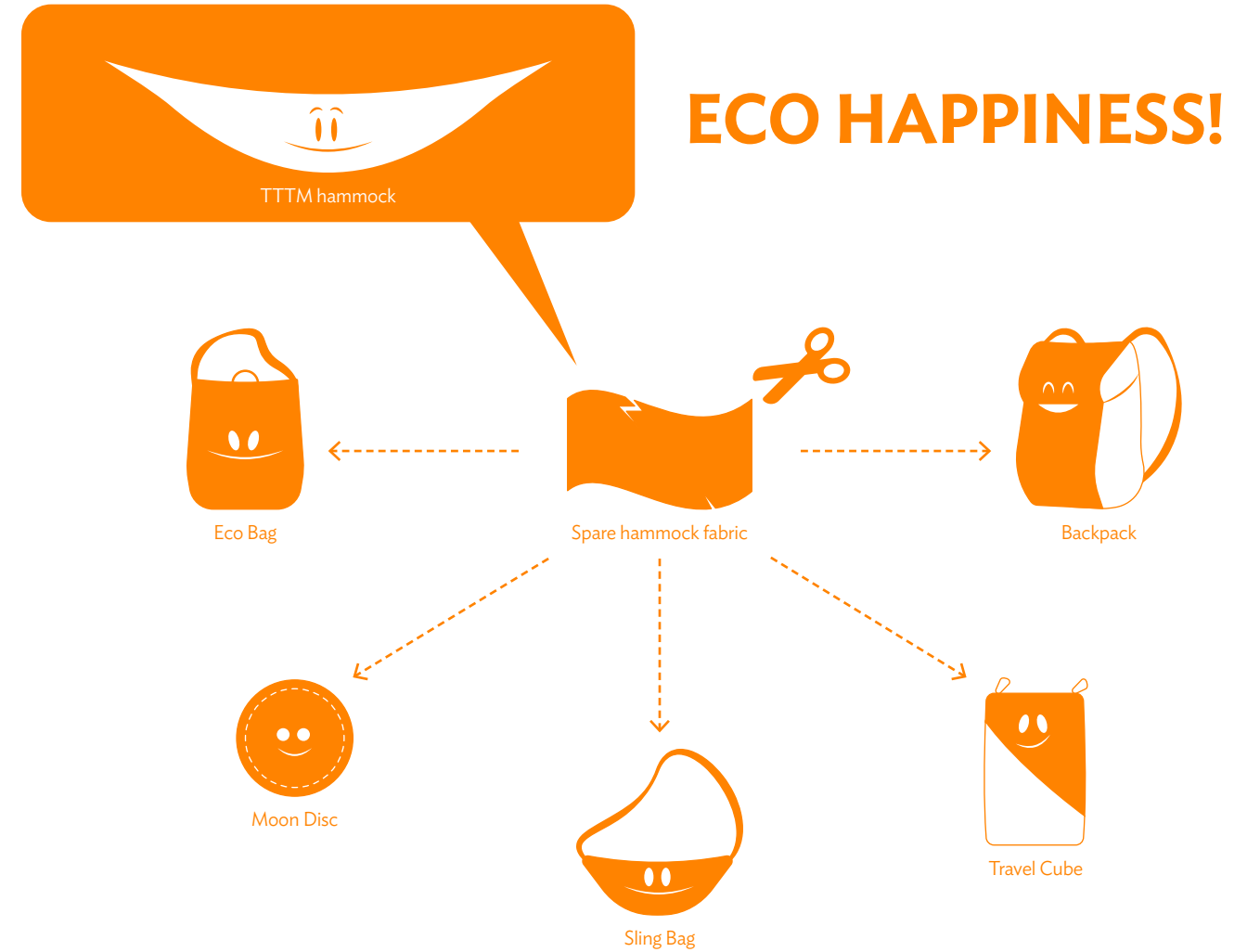

ECO BAGS

SMALL



MEDIUM



LARGE



(TMEB)

S

(TMEBS)



This practical companion in a handbag format will always be with you and does a great job at keeping smaller accessories safe and easily accessible.

Size ————— 30 × 32 × 6 cm
 Weight ————— 40 g
 Capacity ————— 10 l
 Carrying capacity ————— 15 kg

M

(TMEBM)



This dynamic blend of storage capacity, durability and portability will make your everyday life so much more convenient. Taking your groceries home or transporting the essentials for a day by the lake is an absolute delight.

Size ————— 34 × 39 × 6 cm
 Weight ————— 55 g
 Capacity ————— 15 l
 Carrying capacity ————— 15 kg

L

(TMEBL)



This bag handles absolutely anything, including heavier items. Thanks to its lavish interior, there is no need to be selective about what you can carry. The wide handles sit nicely on your shoulders and do not cut in.

Size ————— 46 × 48 × 6 cm
 Weight ————— 75 g
 Capacity ————— 30 l
 Carrying capacity ————— 15 kg

ECO BAGS

(TMEB)

SMALL



Navy & Dark Grey
(TMEBS0603)



Dark Grey & Dark Yellow
(TMEBS0337)



Black & Brown
(TMEBS0708)



Aqua & Orange
(TMEBS1535)

MEDIUM



Aqua & Orange
(TMEBM1535)



Dark Green & Turquoise
(TMEBM0514)



Burgundy & Dark Green
(TMEBM3405)



Royal Blue & Light Blue
(TMEBM3909)



Unique Edition
(TMEBMU)



LARGE



Black & Black
(TMEBL0707)



Royal Blue & Brown
(TMEBL3908)



Dark Grey & Orange
(TMEBL0335)



Dark Green & Turquoise
(TMEBL0514)



Unique Edition
(TMEBLU)



NEW! Premium edition on the next pages!

ECO BAGS PREMIUM



2024 NEW!

"As we have introduced our home and garden line lately, is it just natural that we have leftovers here as well. This allows us to give our Eco Bag range a massive upgrade in comfort and color choice, while the weight and packing size remain almost the same."

(TMEBPR)

MEDIUM

Size ————— 34 × 39 × 6 cm
 Weight ————— 80 g
 Capacity ————— 15 l
 Carrying capacity ————— 15 kg



Terracotta Orange
(TMEBMPR4545)



Olive Brown
(TMEBMPR4343)



Frosty Grey
(TMEBMPR4949)

LARGE

Size ————— 46 × 48 × 6 cm
 Weight ————— 98 g
 Capacity ————— 30 l
 Carrying capacity ————— 15 kg



Terracotta Orange
(TMEBLPR4545)



Olive Brown
(TMEBLPR4343)



Frosty Grey
(TMEBLPR4949)

MINI BACKPACK



- Hidden pocket
- Eco-friendly
- Washable 30 °C
- Foldable
- Top pocket

It is a helpful companion that will save the day, every day! Launched in 2012, our backpack has been refined several times, and now features supreme comfort and superb functionality.

We have updated the mini backpack pouch to be suitable in case of hanging on the wall or placing it in the new Backpacks' dispenser. With the latest upgrade, the bag got an extra pocket for keys and sunglasses — yeeay!



Folded backpack (size reference)



6 cm standard key

(TMMBP)



Royal Blue (TMMBP3939)



Dark Grey (TMMBP0303)



Purple (TMMBP3030)



Black (TMMBP0707)



Army Green & Khaki (TMMBP2422)



Brown & Dark Yellow (TMMBP0837)



Burgundy & Dark Yellow (TMMBP3437)



Turquoise & Royal Blue (TMMBP1439)



Emerald Green & Green (TMMBP3611)



Royal Blue & Orange (TMMBP3935)



Unique Edition (TMMBPU)

Size ————— 28 × 42 × 15 cm
 Weight ————— 115 g
 Capacity ————— 15 l
 Carrying capacity ————— 15 kg

NEW! Premium edition on the next pages!

MINI BACKPACK PREMIUM

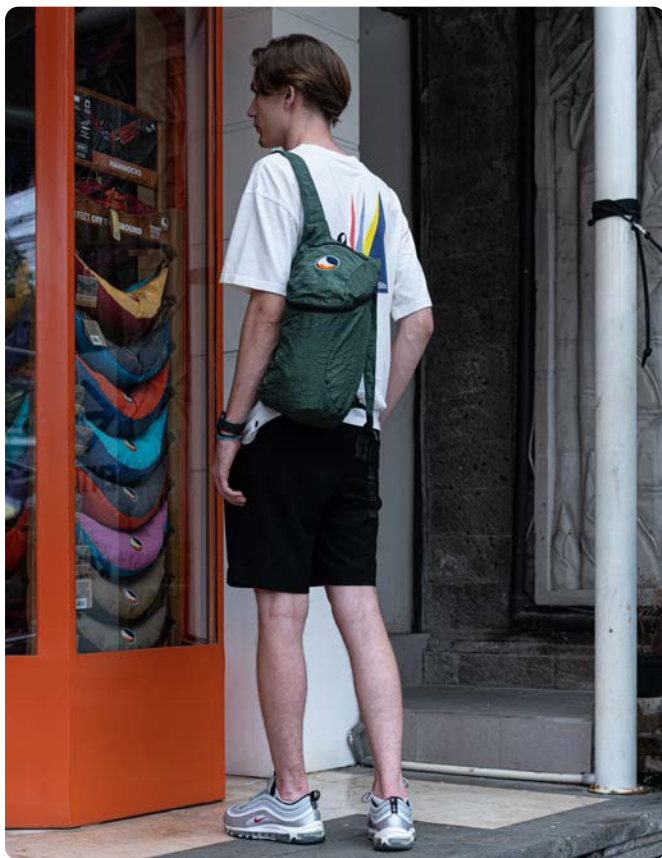

2024 NEW!

Do you like earthy colors that complement your natural style? Our premium fabric combines a remarkably soft and gentle touch with extra sturdiness.

- Hidden pocket
- Eco-friendly
- Washable 30 °C
- Foldable
- Top pocket



Folded backpack (size reference)



6 cm standard key

(TMMBPR)



Natural Beige (TMMBPR4141)



Sparkling Gold (TMMBPR2323)



Terracotta Orange (TMMBPR4545)



Sage Green (TMMBPR4747)

- Size — 28 × 42 × 15 cm
- Weight — 132 g
- Capacity — 15 l
- Carrying capacity — 15 kg

BACKPACK PLUS



- Laptop compartment
- 1 main pocket
- Top pocket with zippable document compartment
- 2 hidden pockets
- Eco-friendly
- Washable 30°C
- Chest strap
- Bottle holder

After the extended success of the Mini Backpack, and answering to countless user requests, we developed a larger version with even more features. The Backpack Plus easily fits 15" laptops and has four practical compartments for flexibility in organising. The secret pockets keep your valuables safe. The chest strap holds the shoulder straps in place to let you carry your belongings easily.



Folded backpack (size reference)



6 cm standard key

(TMPBP)



Orange
(TMPBP35)



Black
(TMPBP07)



Burgundy
(TMPBP34)



Dark Grey
(TMPBP03)



Aqua
(TMPBP15)



Dark Green
(TMPBP05)



Unique Edition
(TMPBPU)



Size ————— 48 × 50 × 20 cm
 Weight ————— 240 g
 Capacity ————— 25 l
 Carrying capacity ————— 15 kg

NEW! Premium edition on the next pages!

BACKPACK PLUS PREMIUM



- Hidden pocket
- Eco-friendly
- Washable 30 °C
- Foldable
- Top pocket

(TMPBPPR)

2024 NEW!

in analogy to the Mini Backpack, we now offer the Backpack Plus in a premium edition as well. This true all-rounder comes in four shiny earth tones, which leaves a more elegant and noble impression.



Folded backpack (size reference)



6 cm standard key



Natural Beige
(TMPBPPR41)



Sparkling Gold
(TMPBPPR23)



Terracotta Orange
(TMPBPPR45)



Sage Green
(TMPBPPR47)

Size ————— 48 × 50 × 20 cm
 Weight ————— 280 g
 Capacity ————— 25 l
 Carrying capacity ————— 15 kg

SLING BAG



Weight ————— 125 g
 Material ————— 70D Crinkle Nylon
 Strap length ————— 55 cm - 100 cm

- Foldable
- Can be used below the cloth
- 4 zipped pockets
- Key chain carabiner can be attached to 5 different locations
- Hidden pocket
- Contrast colour inside
- Wallet structure inside for perfect organisation
- Smartphone pocket
- Partly upcycled material
- Can be used as a hip bag
- Washable at 30°C



(TMSLB)



Black
& Natural Beige
(TMSLB0741)



Burgundy
& Purple
(TMSLB3034)



Dark Green
& Burgundy
(TMSLB0534)



Dark Grey
& Aqua
(TMSLB0315)



Navy Blue
& Sparkling
(TMSLB0623)



Black
(TMSLB0707)



Dark Green
(TMSLB0505)



 Unique Edition
(TMSLBU)

Whether on daily commute, on a bike, for travelling or for just the usual stroll, this take-it-everywhere Ticket to the Moon Sling Bag has lots of storage and pockets to keep you organized with a close-to-body ergonomic fit keeps you organized and comfortable. Fair Produced and made from upcycled materials.

SLING BAG PREMIUM



2024 NEW!

- Foldable
- Can be used below the cloth
- 4 zipped pockets
- Key chain carabiner can be attached to 5 different locations
- Hidden pocket
- Contrast colour inside
- Wallet structure inside for perfect organisation
- Smartphone pocket
- Partly upcycled material
- Can be used as a hip bag
- Washable at 30°C



Folded Sling Bag (size reference)



6 cm standard key

(TMSLBPR)



Natural Beige
(TMSLBPR41)



Sparkling Gold
(TMSLBPR23)



Terracotta Orange
(TMSLBPR45)

Weight ————— 138 g
Material ————— 70D Crinkle Nylon
Strap length ————— 55 cm - 100 cm

TRAVEL CUBES & TRAVEL WALLET



- Eco-friendly
- Washable at 30°C
- Coconut zipper handles
- Practical top handle for easier handling
- Incl. 2 carabiners each

(TMTC)
(TMW)

2024 NEW!

Travel smarter with our packing cubes! Maximize space in your bags, stay organized, and save time. Durable and stylish, they come in three practical sizes and work best in a set. With the included carabiners they can easily be hung as needed. A must-have for any trip!

The travel wallet is a minimalist gadget for safekeeping of your valuables that comes with a mini carabiner so that everything stays in place.

(TMW) **S** (TMTCS) **M** (TMTCM) **L** (TMTCL)



Size ————— 15 × 10 cm
Weight ————— 15 g



Size ————— 19 × 13 × 3 cm
Weight ————— 40 g
Carrying capacity ————— 0,7 l



Size ————— 30 × 18 × 5 cm
Weight ————— 50 g
Carrying capacity ————— 2,7 l



Size ————— 46 × 48 × 6 cm
Weight ————— 66 g
Carrying capacity ————— 6,3 l



Available separately or in a set —
(1 Set = 1x S, 1x M, 1x L; incl. 4 carabiners)



Travel Cube Set
Aqua
& Dark Grey
(TMTCSET1534)



Unique Edition
(TMTCSETU)



Travel Cube Set
Royal Blue
& Navy Blue
(TMTCSET1503)



Travel Cube Set
Burgundy &
Dark Green
(TMTCSET3405)



Travel Cube Set
Brown &
Army Green
(TMTCSET0824)

TRAVEL CUBES & TRAVEL WALLET

(TMTTC)
(TMW)

TRAVEL WALLET



Aqua
(TMW15)



Burgundy
(TMW34)



Dark Grey
(TMW03)

SMALL



Aqua & Dark Grey
(TMTCS1503)



Royal Blue & Navy Blue
(TMTCS3906)



Burgundy & Dark Green
(TMTCS3405)



Brown & Army Green
(TMTCS0824)



Unique Edition
(TMTCSU)



MEDIUM



Aqua & Dark Grey
(TMTCM1503)



Royal Blue & Navy Blue
(TMTCM3906)



Burgundy & Dark Green
(TMTCM3405)



Brown & Army Green
(TMTCM0824)



Unique Edition
(TMTCMU)



LARGE



Aqua & Dark Grey
(TMTCL1503)



Royal Blue & Navy Blue
(TMTCL3906)



Burgundy & Dark Green
(TMTCL3405)



Brown & Army Green
(TMTCL0824)



Unique Edition
(TMTCLU)



POCKET MOON DISC

(TMPDISC)



This is the ultimate toy for all ages — fun to throw, easy to catch and bring along. The rim that is filled with rolled left-over fabric makes it fly perfectly without fear of hurting anyone or it rolling away. As it does not have hard and sharp edges it is great for indoor use and for pool parties. It folds up in a small pouch for carrying and safekeeping.

Diameter ————— 26 cm
Weight ————— 120 g



Burgundy
(TMPDISC34)



Aqua
(TMPDISC15)



Orange
(TMPDISC35)



Purple
(TMPDISC30)

ULTIMATE MOON DISC

(TMUDISC)



This travelling and everyday toy is entirely handcrafted from left-over parachute fabric and has the same dimensions as standard ultimate frisbees. It navigates through the air just as brilliant as a professional disk, while it folds down surprisingly small and is insusceptible to deforming or breaking.

Diameter ————— 31.5 cm
Weight ————— 175 g



Burgundy
(TMUDISC34)



Aqua
(TMUDISC15)



Orange
(TMUDISC35)



Purple
(TMUDISC30)

LIFESTYLE PRODUCTS

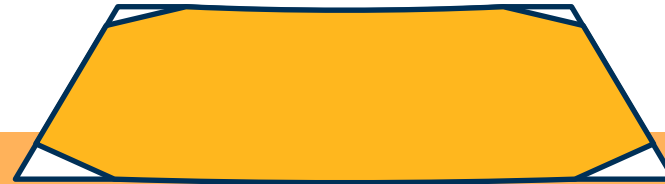
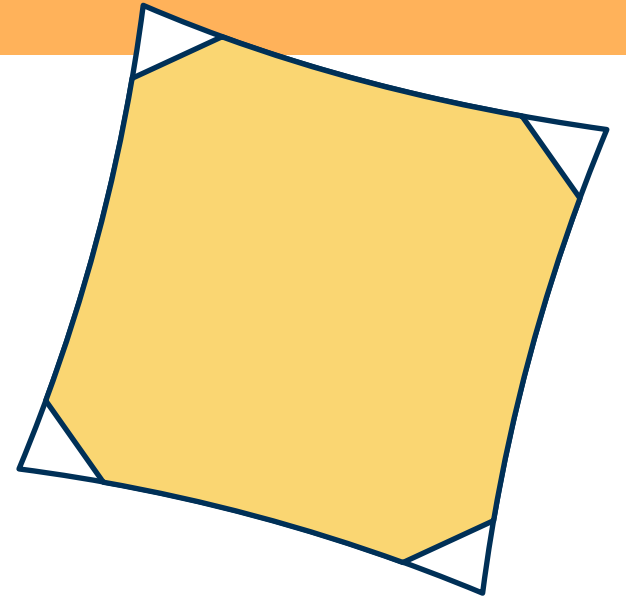
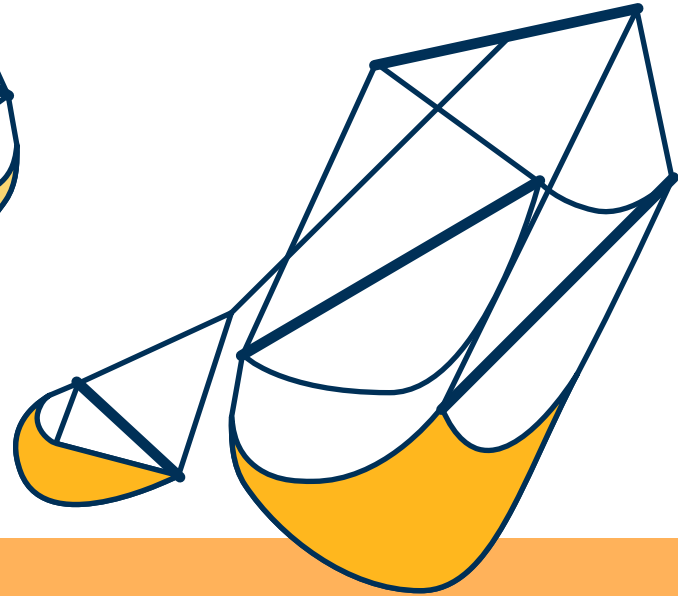

MOONCHAIR



- High-grade parachute nylon
- Skin-friendly
- Fast-drying
- Mildew resistant
- Adjustable seating position
- 2 side pockets
- Length-adjustable footrest

(TMMC)

Strong, durable and easy to bring along. A comfortable chair that releases all pressure from your spine. Thanks to its smart, stainless steel angle adjustment ring, you can find just the right position. The included length-adjustable footrest does its magic and lets you sink even deeper into relaxation mode. Using our signature nylon fabric in combination with aluminium tubing and quality webbing, this foldable chair is just ideal for gaming at home, as an exotic feature for your balcony, or to doze off after a day's hike under your favorite tree watching the sunset. The set is complete with its carrying bag, suspension rope and a 10kN swivel-carabiner for hassle-free installation.

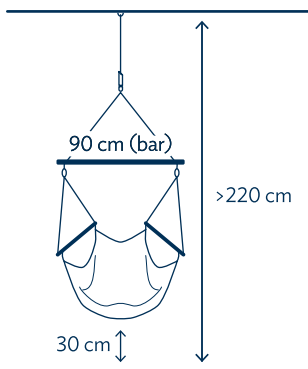

2024 NEW COLOR!
Emerald Green
(TMMC36)

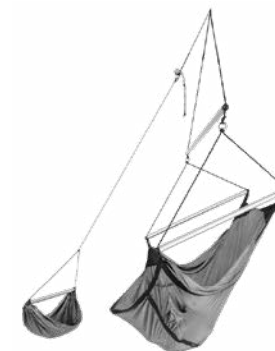

Dark Grey
(TMMC03)



Royal Blue
(TMMC39)



Black
(TMMC07)



Burgundy
(TMMC34)



Army Green
(TMMC24)

- Max. load ————— 120 kg
- Weight ————— 1700 g
- Aluminium tubing ———— Ø 2.4 cm

MINI MOONCHAIR



A special smaller Moonchair aka. “portable carousel” designed for young dreamers up to 12 years of age. A great gift that will bring many years of joy. It comes with a carabiner and rope for easy and intuitive setup.



Max. load ————— 60 kg
 Weight ————— 1000 g
 Aluminium tubing ———— Ø 2.4 cm

(TMMMC)

Colors



Purple
(TMMMC30)



Royal Blue
(TMMMC39)

BEACH BLANKET

(TMBB)

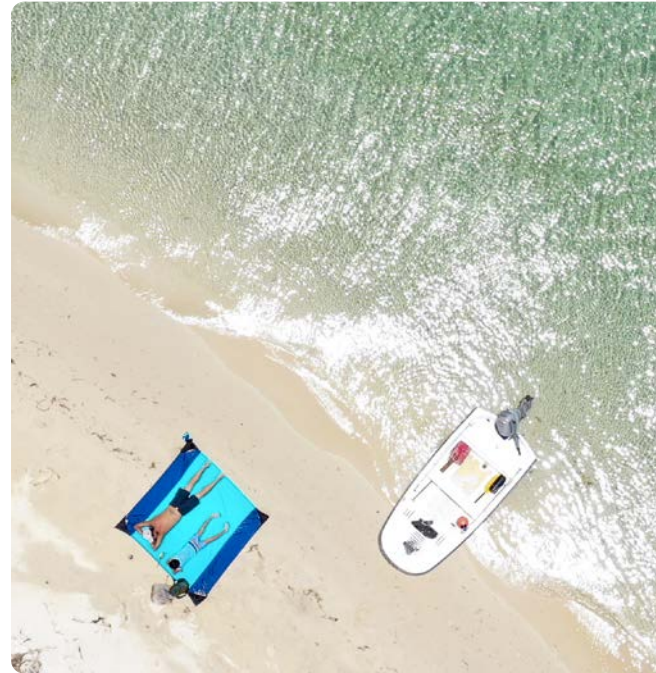

This convenient picnic blanket provides an instant and welcoming sitting opportunity for those that want their feet ON the ground for a change. The integrated tent peg loops and corner pockets, for sand or rocks, make sure it always stays in place. You can also use the beach blanket as a sun shield or as a wind deflector by attaching ropes to the loops. Ticket to the Moon Beach Blankets pack in a detachable pouch.

Size ————— 213 × 213 cm
 Weight ————— 420 g



Aqua & Orange
(TMBB1535)



Emerald Green & Green
(TMBB3611)



Royal Blue & Light Blue
(TMBB3909)

- High-grade parachute nylon silk
- Skin-friendly
- Fast-drying
- Mildew-resistant
- Compact and lightweight
- Corner pockets
- Compact pouch

T-SHIRT

(TMSHIRTW/
TMSHIRTM)



Comfortable Cotton T-shirts by Ticket to the Moon are available in both male and female versions.

- Female ———— XXS - XL
- Male ———— XS - XL
- Weight ———— 100 g



COMMUNITY



SOCIAL & ENVIRONMENTAL PROJECTS

Over the past years, we have been very fortunate. Together with our friends and partners in Sumba, we could drastically improve the local livelihood situation. In fact, things have improved by such a degree that the TTTM Foundation is now coming to an end. We all are tremendously proud of the developments of the project and are now eagerly following our Sumbanese friends' steps and standing by their side with advice upon request. With much excitement, we are now shifting our focus and energies to other selected social and environmental projects that we believe in and who are working towards similar goals to make the world a better place. We are an organisation with a strong commitment to sustainability and social responsibility. Therefore we feel a strong calling to give back to society and to support those in need. Amongst other activities, we have therefore launched a couple of collaborations that involve donating for example. As we are in the reorientation process of our social endeavors, let us know about any interesting projects that could be interesting partners!



SOLEMEN

One of them is the humanitarian project "Solemen". Solemen is a non-profit organization based in Bali, Indonesia, that provides various forms of support to people with disabilities, chronic illnesses, and other life-threatening conditions. They assist individuals who are unable to afford medical treatment, rehabilitation, or other basic necessities. They also organize campaigns and events to raise awareness about various issues affecting the community. Ticket To The

Moon recognizes the great work that Solemen is doing and wants to help them with their cause. Our company has provided printed eco-bags that are made from eco-friendly materials and are reusable. These eco-bags feature Solemen's and our company logo and are designed to help raise awareness about Solemen's mission and promote sustainable practices. Through this project, Ticket To The Moon hopes to encourage people to use eco-bags instead of single-use plastic bags. Plastic pollution is a significant environmental issue, and it is crucial that we take steps to reduce our plastic usage. By donating eco-bags to Solemen, we aim to help reduce plastic waste while also supporting a great cause. We are proud to support Solemen's mission, creates sources of income and to help make a positive impact in the community. Our team believes that it is important to give back to society and we will continue to find ways to support worthy causes. Another way we support Solemen is by providing Moonchairs to disadvantaged families amongst many others with disabled children.

These families were previously hidden away in a poor area of Denpasar without support or care from the outside. Through Solemen working closely with the government of Bali they all now enjoy new lives in Denpasar area of Renon in clean solid housing together with wheelchair access. The children benefit greatly from regular therapy, provision of nutritionally balanced food and ongoing emotional support by the charity. Previously none of the children had the opportunity to experience play. They are now even getting into all sorts of mischief by their newly discovered (and wild) swinging possibilities. What a joy!



SOCIAL & ENVIRONMENTAL PROJECTS



PROJECT WINGS

Project Wings is a growing German NGO that is currently building the world's largest recycling village in Indonesia from 250 tons of plastic waste. They aim to tackle three major global issues: species extinction, tropical deforestation,

and plastic pollution. The organization is implementing a self-sustaining system run by locals that combines environmental protection, nature conservation, and animal welfare. They use an innovative approach to turn plastic waste into Eco-bricks, which are then used to construct affordable buildings. The NGO is also involved in protecting



the rainforest, animal welfare, promoting alternatives to plastic and education. Their future plans include building a sustainable marketplace, sports ground and organic restaurant. Project Wings collaborates with various partners and supporters to realize their vision. We support them with custom printed bags as a start to give to participants of round table meetings with NGOs and politicians as well as for funding activities in Germany to raise mindfulness for this important mission. We will support their crew with hammocks for the com-

munity patrol and for sleeping cabins for the team and supporters. We are planning to do some projects with them in the near future to raise awareness in Sumatra (more projects and collaborations are likely to come in the future).

One man`s trash is another man`s treasure!

project-wings.de



QUALITY



Every product is checked before leaving the production.

Quality is our third pillar (where it gets really nerdy) besides acting **Ethical** and our **Community** approach. To follow the hammock flow, let us start with the incoming material. Upon its reception, samples of all security-relevant components are collected and taken into our testing room.

TESTING MACHINE



Product Testing Machine

Before entering production, they are torn by our tensile testing machine, while the measuring sensors record the parameters and save a protocol for our QC database. Some parts, like the S-Hooks for example are tested constantly from each batch produced. For fabrics we developed a unique testing procedure that makes sure that the fabric is suitable for hammocks and that the quality stays the same for every batch and colour. The sewing of our straps is monitored. We also test final products with scrutiny to ensure that you receive perfect products made with love in Bali.

TICKET TO THE MOON

Headquarter Bali:

+62 361 419 288

office@tickettothemoon.com

tickettothemoon.com

Ticket to the Moon Europe:

+43 660 637 8417

office.europe@tickettothemoon.com

eu.tickettothemoon.at



Fly through
TTTTM'S
FACTORY!